

## STELLA-VSM

IESNA Type V (square) for wide areas lighting such as car parks. Compatible with up to 30 mm LES size COBs.

### TECHNICAL SPECIFICATIONS:

Dimensions	Ø 90.0 mm
Height	20.7 mm
Fastening	screw
Colour	black
Box size	480 x 280 x 300 mm
Box weight	9.2 kg
Quantity in Box	135 pcs
ROHS compliant	yes ⓘ



### MATERIAL SPECIFICATIONS:

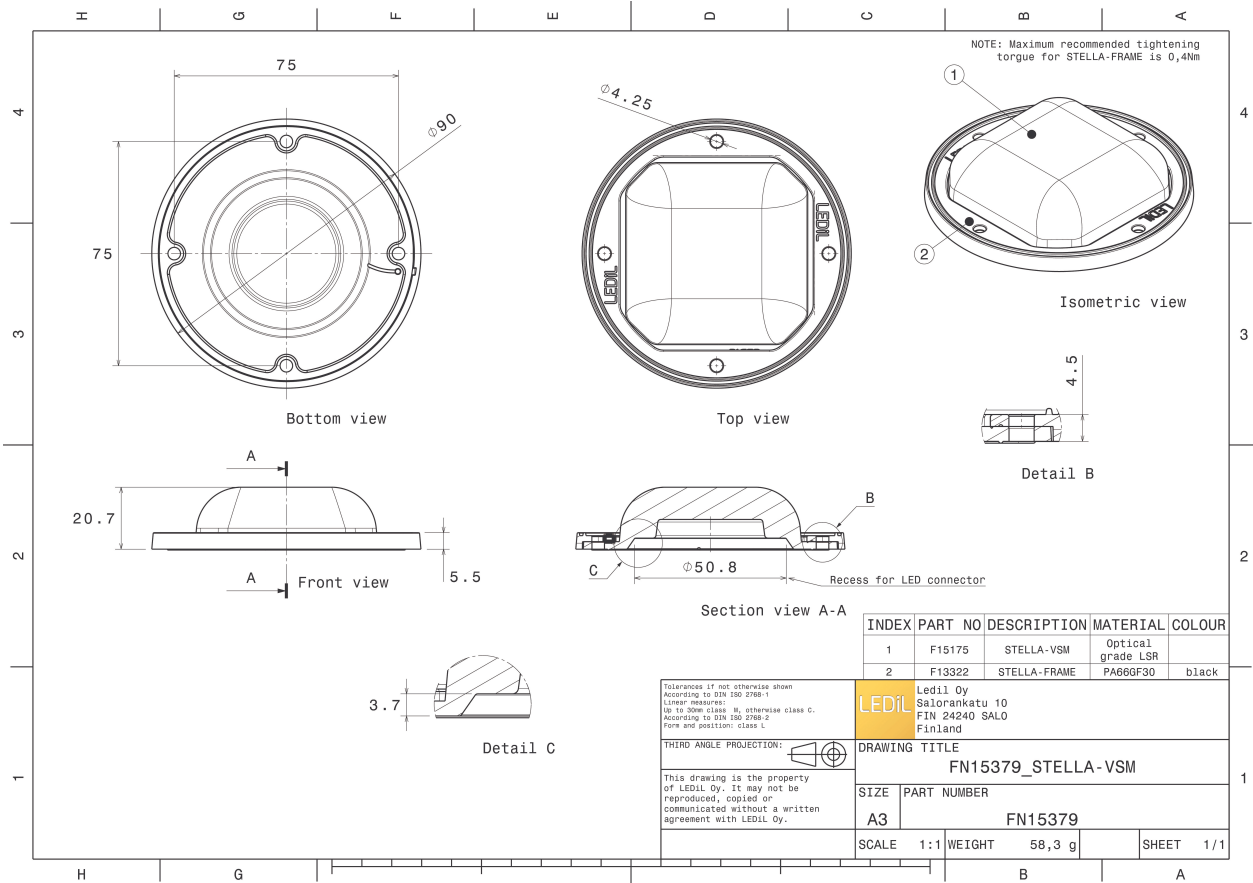

Component	Type	Material	Colour
STELLA-VSM	Lens	Silicone	clear
STELLA-FRAME	Holder	PA66	black

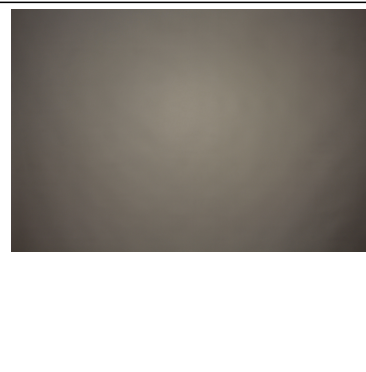
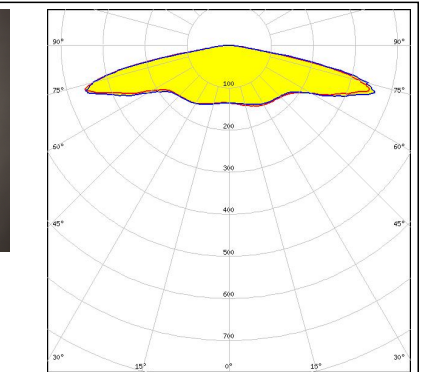
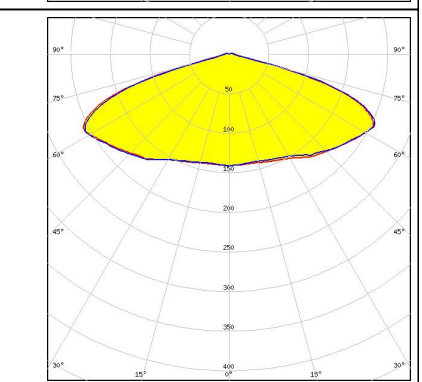
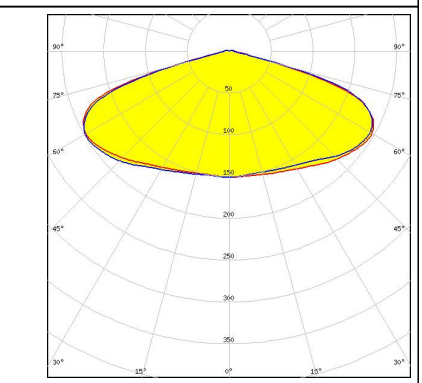
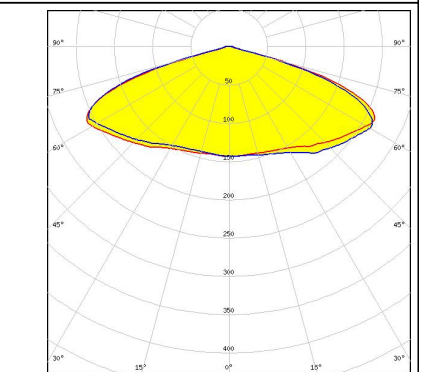

#### PHOTOMETRIC DATA (MEASURED):

<p>bridgelux.</p> <p>LED V18 Gen7</p> <p>FWHM Asymmetric</p> <p>Efficiency 94 %</p> <p>Peak intensity 0.360 cd/lm</p> <p>Required components:</p> <p>Bender Wirth: 439 Typ L3</p>		
<p>bridgelux.</p> <p>LED V22 Gen7</p> <p>FWHM Asymmetric</p> <p>Efficiency 93 %</p> <p>Peak intensity 0.300 cd/lm</p> <p>Required components:</p>		
<p>bridgelux.</p> <p>LED V22 Gen7</p> <p>FWHM Asymmetric</p> <p>Efficiency 94 %</p> <p>Peak intensity 0.300 cd/lm</p> <p>Required components:</p> <p>TE: 2213480-1</p>		
<p>bridgelux.</p> <p>LED V22 Gen7</p> <p>FWHM Asymmetric</p> <p>Efficiency 94 %</p> <p>Peak intensity 0.310 cd/lm</p> <p>Required components:</p> <p>Bender Wirth: 431 Typ Z1</p>		

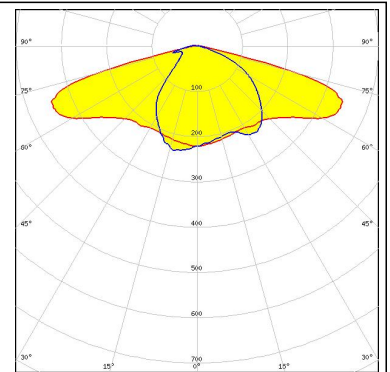
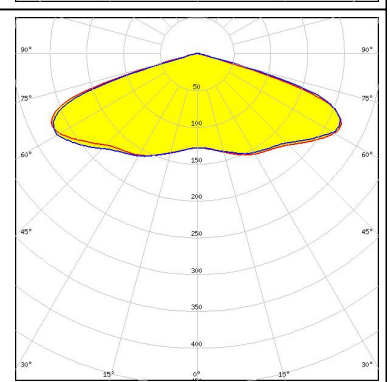
#### PHOTOMETRIC DATA (MEASURED):

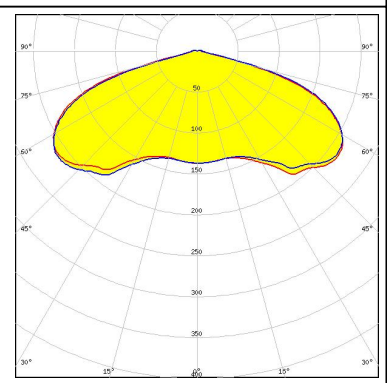
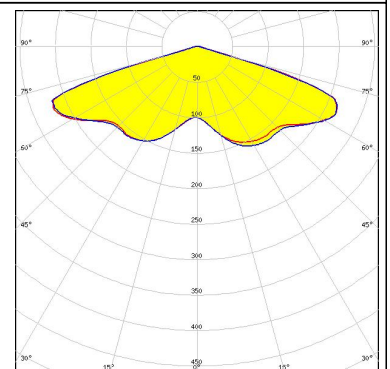
<p>bridgelux.</p> <p>LED           Vero SE 13</p> <p>FWHM        Asymmetric</p> <p>Efficiency    90 %</p> <p>Peak intensity 0.620 cd/lm</p> <p>Required components:</p>		
<p>bridgelux.</p> <p>LED           Vero SE 18</p> <p>FWHM        Asymmetric</p> <p>Efficiency    94 %</p> <p>Peak intensity 0.370 cd/lm</p> <p>Required components:</p>		
<p>bridgelux.</p> <p>LED           Vero SE 29</p> <p>FWHM        Asymmetric</p> <p>Efficiency    94 %</p> <p>Peak intensity 0.260 cd/lm</p> <p>Required components:</p>		
<p>bridgelux.</p> <p>LED           VERO13</p> <p>FWHM        Asymmetric</p> <p>Efficiency    93 %</p> <p>Peak intensity 0.600 cd/lm</p> <p>Required components:</p>		



### PHOTOMETRIC DATA (MEASURED):



LED VERO18  
FWHM Asymmetric  
Efficiency 94 %  
Peak intensity 0.400 cd/lm  
Required components:

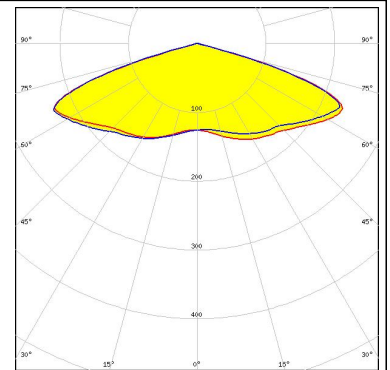

### CITIZEN

LED CLL05x/CLU05x  
FWHM Asymmetric  
Efficiency 94 %  
Peak intensity 0.260 cd/lm  
Required components:

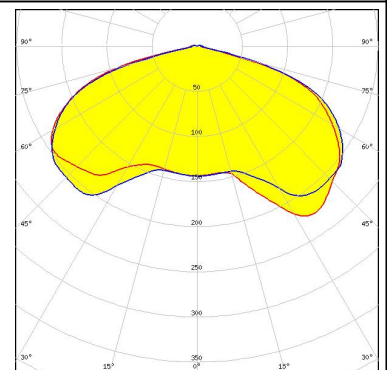

LED CMA2550  
FWHM Asymmetric  
Efficiency 94 %  
Peak intensity 0.400 cd/lm  
Required components:

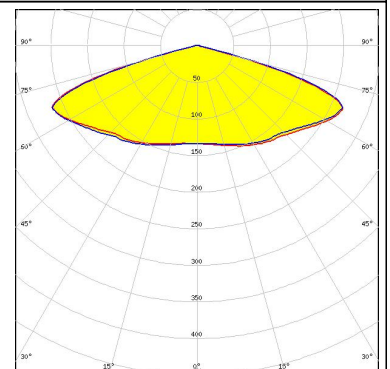

LED CXA/B 1816 & CXA/B 1820 & CXA 1850  
FWHM Asymmetric  
Efficiency 93 %  
Peak intensity 0.600 cd/lm  
Required components:

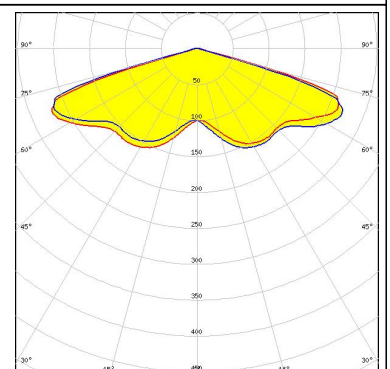

#### PHOTOMETRIC DATA (MEASURED):



LED CXA/B 3590  
 FWHM Asymmetric  
 Efficiency 94 %  
 Peak intensity 0.250 cd/lm  
 Required components:

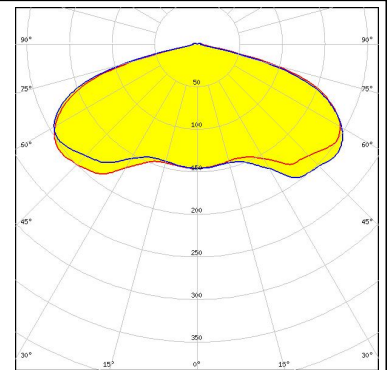

LED LUXEON CoB 1208  
 FWHM Asymmetric  
 Efficiency 94 %  
 Peak intensity 0.540 cd/lm  
 Required components:

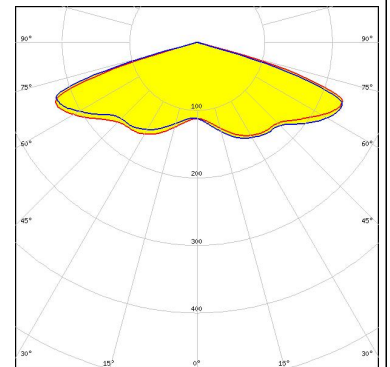

LED LUXEON CoB 1211  
 FWHM Asymmetric  
 Efficiency 93 %  
 Peak intensity 0.350 cd/lm  
 Required components:  
 Bender Wirth: 431 Typ L3

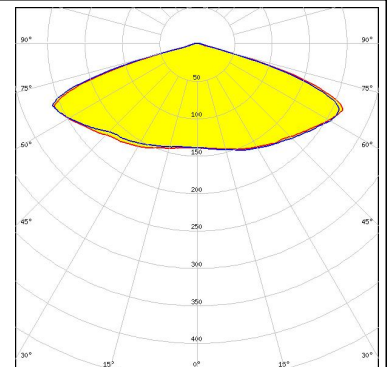

LED LUXEON CoB 1321  
 FWHM Asymmetric  
 Efficiency 93 %  
 Peak intensity 0.250 cd/lm  
 Required components:

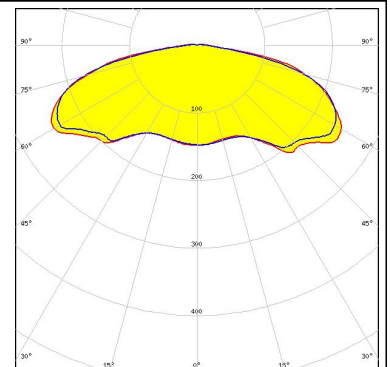

#### PHOTOMETRIC DATA (MEASURED):

#### LUMILEDS

LED LUXEON CoB 1825  
 FWHM Asymmetric  
 Efficiency 93 %  
 Peak intensity 0.250 cd/lm  
 Required components:

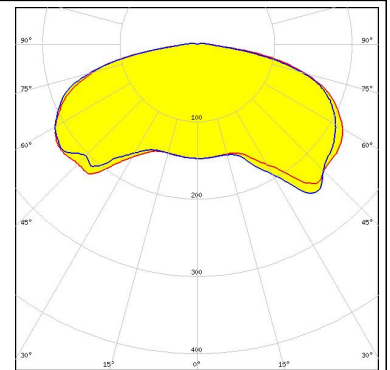

#### NICHIA

LED COB H-Type  
 FWHM Asymmetric  
 Efficiency 93 %  
 Peak intensity 0.290 cd/lm  
 Required components:

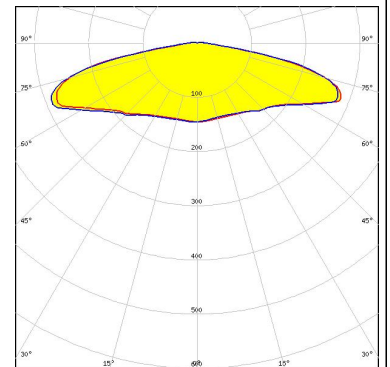

#### NICHIA

LED COB J-Type  
 FWHM Asymmetric  
 Efficiency 94 %  
 Peak intensity 0.500 cd/lm  
 Required components:

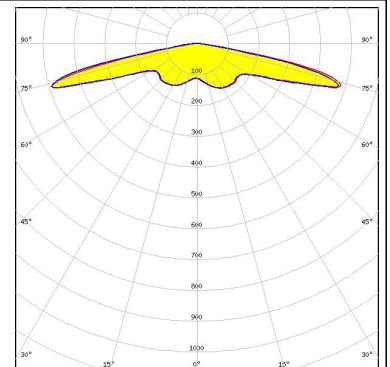

#### SAMSUNG

LED COB D Series LES 14.5 mm  
 FWHM Asymmetric  
 Efficiency 93 %  
 Peak intensity 0.470 cd/lm  
 Required components:

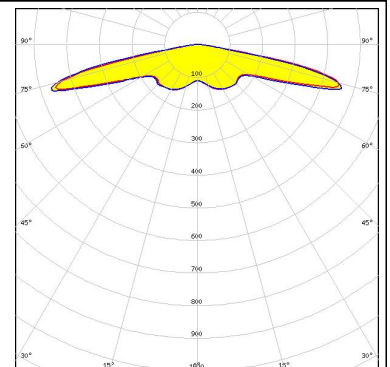
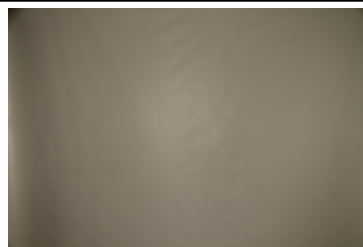

#### PHOTOMETRIC DATA (MEASURED):

### SAMSUNG

LED COB D Series LES 22 mm  
 FWHM Asymmetric  
 Efficiency 93 %  
 Peak intensity 0.300 cd/lm  
 Required components:

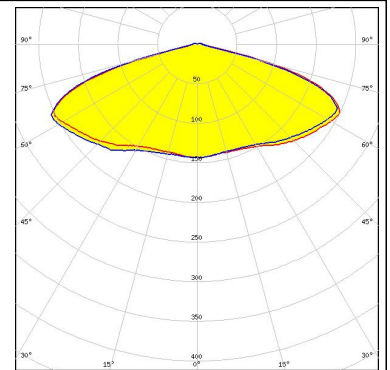

LED MJT COB LES 14.5  
 FWHM Asymmetric  
 Efficiency 94 %  
 Peak intensity 0.500 cd/lm  
 Required components:  
 Bender Wirth: 433 Typ Z1

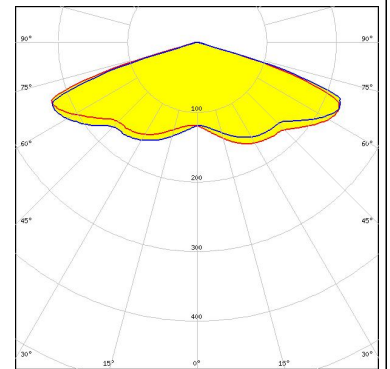

LED MJT COB LES 22  
 FWHM Asymmetric  
 Efficiency 94 %  
 Peak intensity 0.310 cd/lm  
 Required components:  
 Bender Wirth: 431 Typ Z1

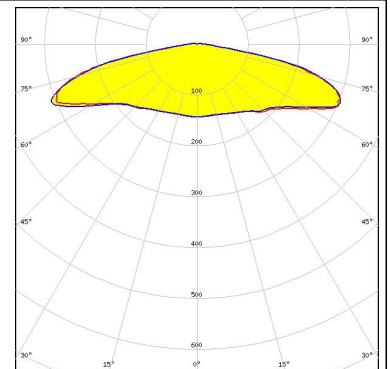

LED MJT COB LES 33  
 FWHM Asymmetric  
 Efficiency 94 %  
 Peak intensity 0.230 cd/lm  
 Required components:

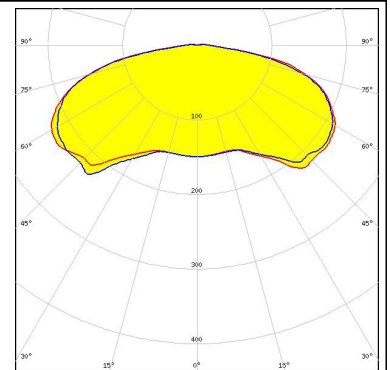

**PHOTOMETRIC DATA (SIMULATED):**

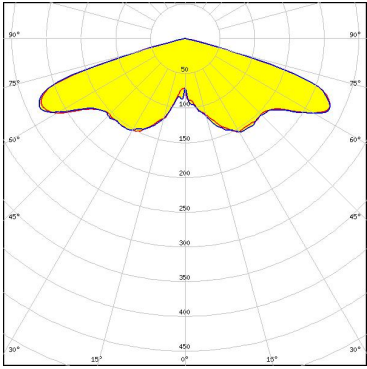
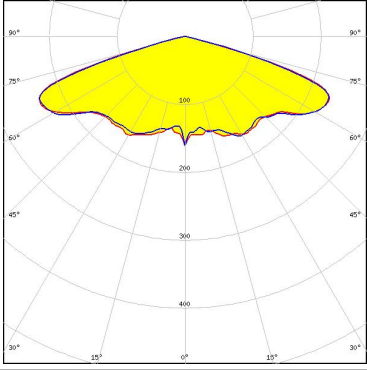
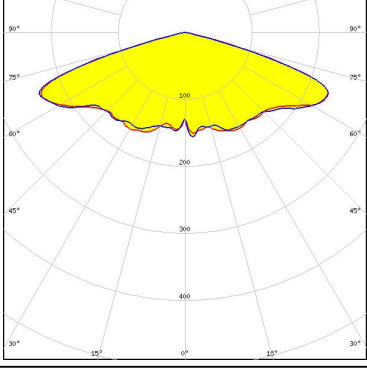
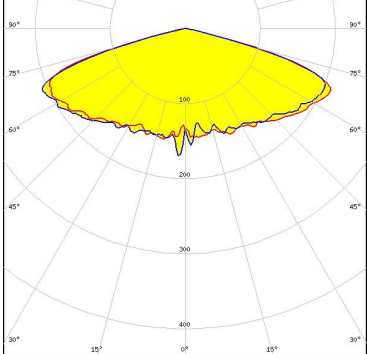
<p>bridgelux.</p> <p>LED V10 Gen7 FWHM Asymmetric Efficiency 93 % Peak intensity 0.510 cd/lm Required components: Bender Wirth: 434 Typ Z1</p>	
<p>bridgelux.</p> <p>LED V13 Gen7 FWHM Asymmetric Efficiency 98 % Peak intensity 0.400 cd/lm Required components:</p>	
<p>bridgelux.</p> <p>LED V13 Gen7 FWHM Asymmetric Efficiency 97 % Peak intensity 0.380 cd/lm Required components: Bender Wirth: 477 Typ Z1</p>	
<p><b>CITIZEN</b></p> <p>LED CLL04x/CLU04x FWHM Asymmetric Efficiency 93 % Peak intensity 0.320 cd/lm Required components:</p>	

#### PHOTOMETRIC DATA (SIMULATED):

### CITIZEN

LED CLL04x/CLU04x  
FWHM Asymmetric  
Efficiency 94 %  
Peak intensity 0.330 cd/lm  
Required components:  
Bender Wirth: 431 Typ Z1

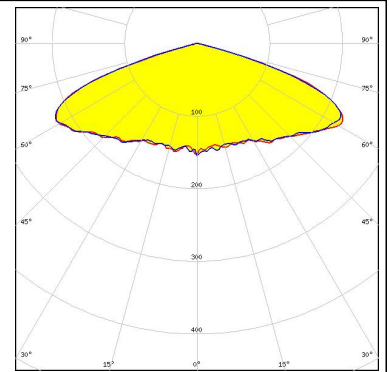

### CREE

LED CXA/B 25xx  
FWHM Asymmetric  
Efficiency 94 %  
Peak intensity 0.350 cd/lm  
Required components:

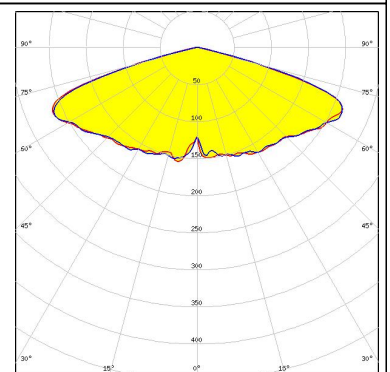

### CREE

LED CXA/B 30xx  
FWHM Asymmetric  
Efficiency 94 %  
Peak intensity 0.300 cd/lm  
Required components:  
Bender Wirth: 447 Typ Z1

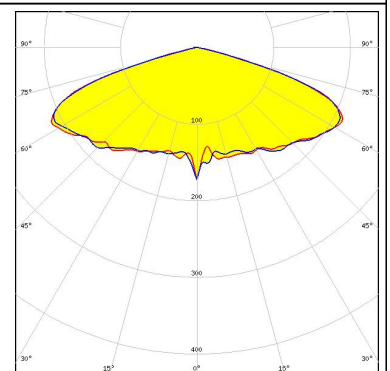

### LUMILEDS

LED LUXEON CoB 1216/1812  
FWHM Asymmetric  
Efficiency 92 %  
Peak intensity 0.270 cd/lm  
Required components:

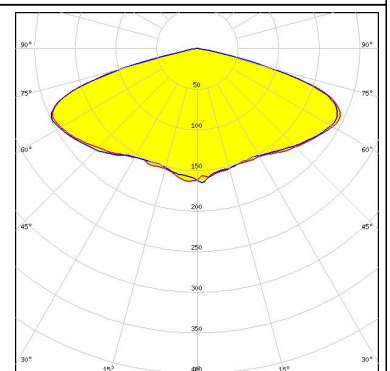



### PHOTOMETRIC DATA (SIMULATED):



LED CXM-22  
FWHM Asymmetric  
Efficiency 94 %  
Peak intensity 0.300 cd/lm  
Required components:  
Bender Wirth: 431 Typ Z1

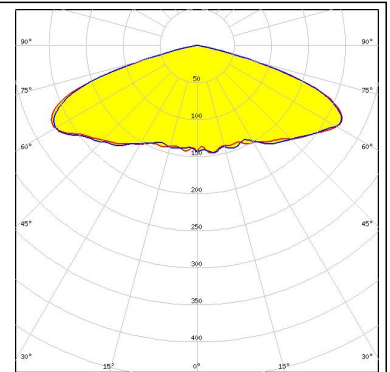

### TRIDONIC

LED SLE G6 LES19  
FWHM Asymmetric  
Efficiency 94 %  
Peak intensity 0.390 cd/lm  
Required components:

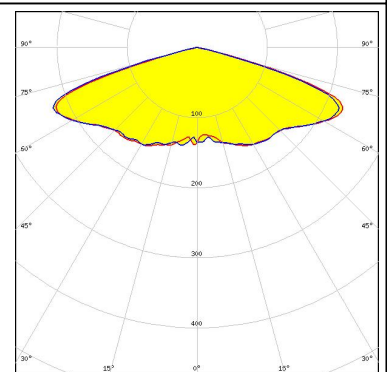

### TRIDONIC

LED SLE G6 LES23  
FWHM Asymmetric  
Efficiency 94 %  
Peak intensity 0.330 cd/lm  
Required components:

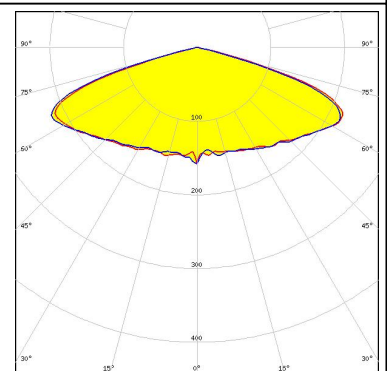

### GENERAL INFORMATION:

NOTE: The typical beam angle will be changed by different color, chip size and chip position tolerance. The typical total beam angle is the full angle measured where the luminous intensity is half of the peak value.

Due to use of high power COB's with this product, special attention to proper thermal design is highly recommended. LEDiL has no liability for direct, indirect or consecutive damages arising from the LEDiL products being used outside of the recommended temperature range.

### MATERIALS:

As part of our continuous research and improvement processes, and to ensure the best possible quality and availability of our products, LEDiL reserves the right to change material grades without notice.

### PRODUCT DATA USER AGREEMENT AND DISCLAIMER:

The measured data in the provided downloadable LEDiL Product Datasheets and Mechanical 2D-Drawings is rounded and provided as reference for planning. LEDiL Oy's optical specifications have been verified by conducting performance testing of the products in accordance with the company's quality system. The reported data are averaged results of multiple measurements with typical variation. LEDiL Oy reserves the right to without prior notification make changes and improvements to its products.

LEDiL Oy assumes neither warranty, nor guarantee nor any other liability of any kind for the contents and correctness of the provided data. The provided data has been generated with highest diligence but the provided data may in reality not represent the complete possible variation range of all intrinsic parameters. Therefore, in certain cases a deviation from the provided data could occur.

LEDiL Oy reserves the right to undertake technical changes of its products without further notification which could lead to changes in the provided data. LEDiL Oy assumes no liability of any kind for the possible deviation from any provided data or any other damage resulting from the usage of the provided data.

The user agrees to this disclaimer and user agreement with the download or usage of the provided files.

#### LEDiL Oy

Joensuunkatu 13  
FI-24240 SALO  
Finland

#### LEDiL Inc.

228 West Page Street  
Suite D  
Sycamore IL 60178  
USA

#### Local sales and technical support

[www.ledil.com/  
where\\_to\\_buy](http://www.ledil.com/where_to_buy)

#### Shipping locations

Salo, Finland  
Hong Kong, China

#### Distribution Partners

[www.ledil.com/  
where\\_to\\_buy](http://www.ledil.com/where_to_buy)