

## SPECIFICATION

Part No. : **PCS.07.A**

Product Name : Low Profile Cellular SMD Dielectric Antenna  
GSM / CDMA / DCS / PCS / WCDMA /  
UMTS /HSDPA / GPRS / EDGE  
824~960MHz/1710~2170MHz

Features : High Efficiency Multi-Band SMD antenna  
Low profile 35mm \* 7mm \* 3mm  
**RoHS Compliant**

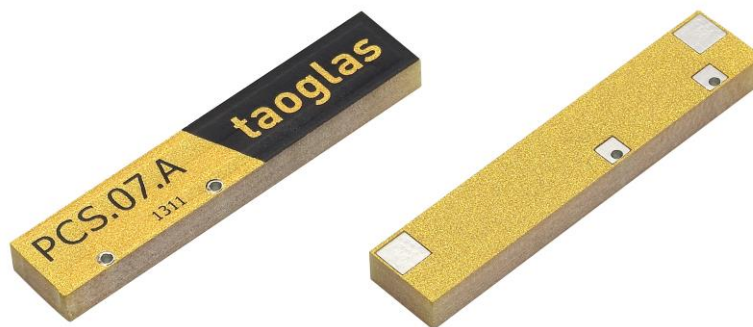

## 1. Introduction

The PCS.07.A is a low profile SMT cellular antenna designed for direct SMT mount on the device PCB. It provides highest efficiency in very small factor 35\*7\*3mm. It is more resistant to detuning compared to other antenna integrations. If tuning is required it can be tuned for the device environment, while there is no need for new tooling. Its rectangular shape and very small size makes it very easy to integrate – can be mounted directly on the edge of the PCB board.

The PCS.07 antenna is suitable for lower cost cellular applications and is especially suitable for telematics and automotive sector. If higher efficiency or improved radiated spurious emissions are required, especially on smaller ground-planes, please use our PA series antennas, PA.25 or PA.710.

## 2. Specification Table

GSM Band					
	GSM 850	GSM 900	DCS	PCS	WCDMA I
Frequency (MHz)	824~896	880~960	1710~1880	1850~1990	1920~2170
Peak Gain (dBi)*	-1.96	-1.77	2.90	2.83	2.57
Average Gain (dBi)*	-4.68	-4.44	-2.50	-2.68	-2.42
Efficiency (%)*	32.02	31.06	45.14	52.82	50.11
Return Loss (dB)*	< -3	< -4	< -5	< -7	< -6
Polarization	Linear				
Impedance	50 Ω				
MECHANICAL					
Antenna Dimensions	35mm x 7mm x 3mm				
Material	Polymer				
Soldering Type	SMT through Reflow				
ENVIRONMENTAL					
Operation Temperature	-40°C ~ +85°C				
Storage Temperature	-40°C ~ +85°C				

\* all measurements taken on 100mm length ground plane EVB board.

### 3. Antenna Characteristics

#### 3.1. Return Loss

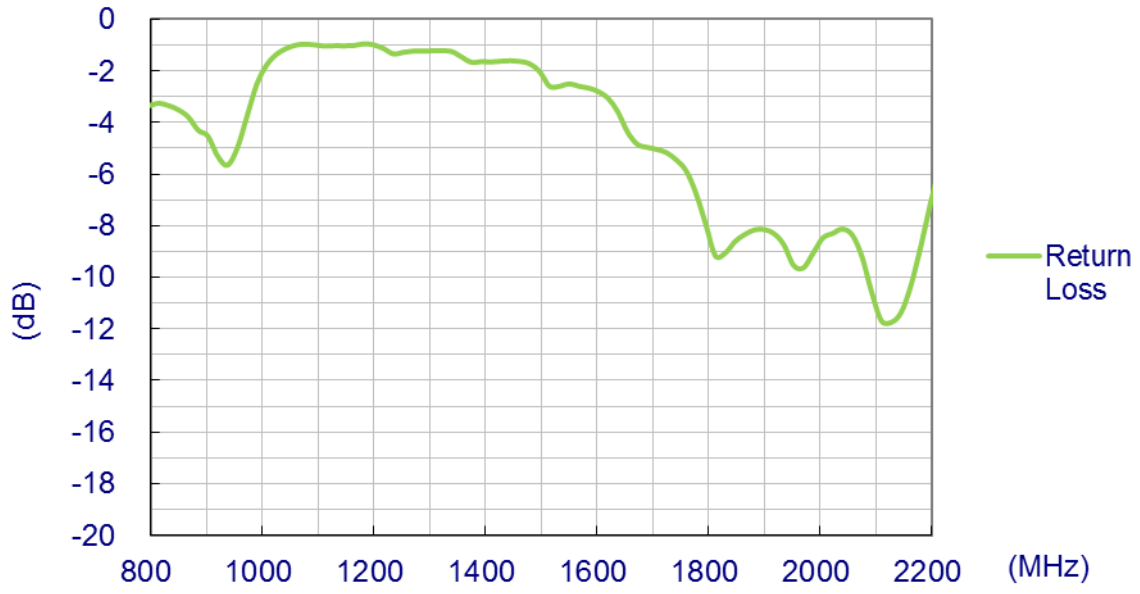

#### 3.2. Maximum Gain

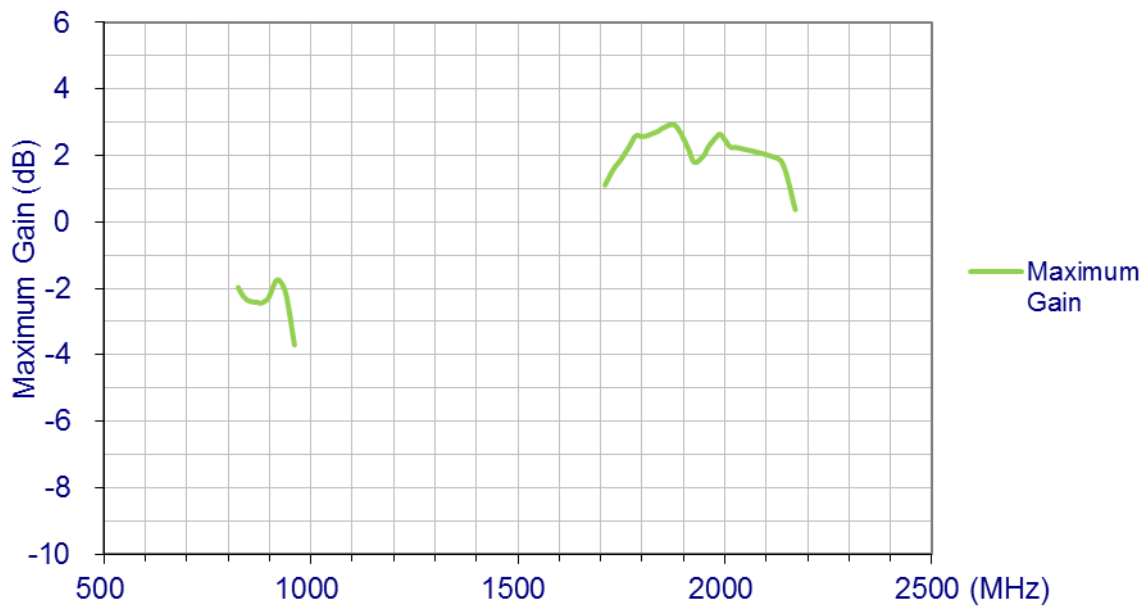

### 3.3. Average Gain

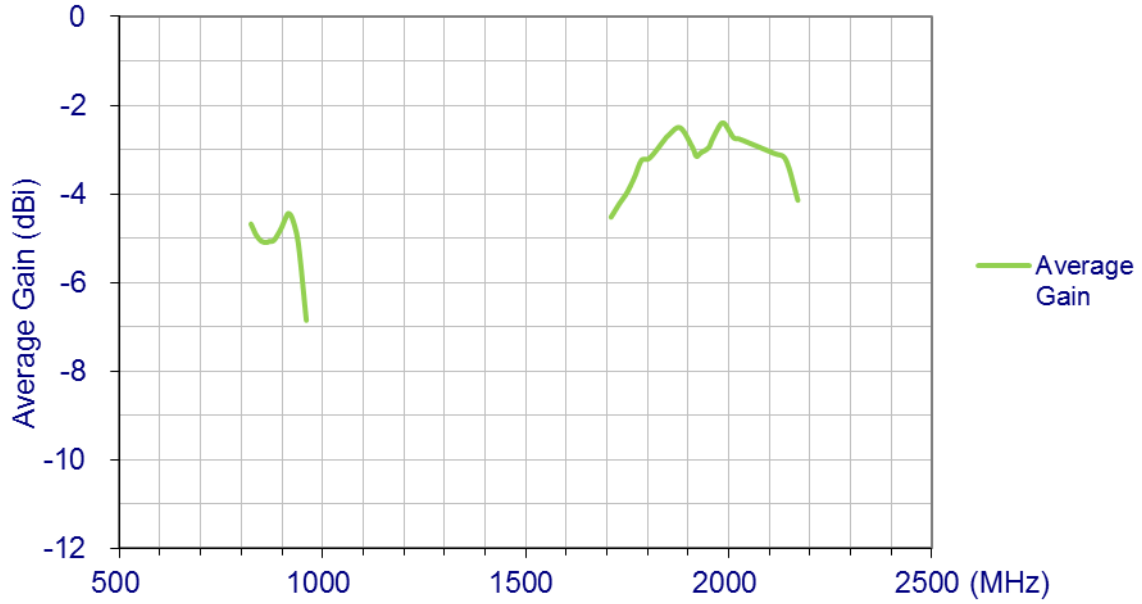

### 3.4. Efficiency

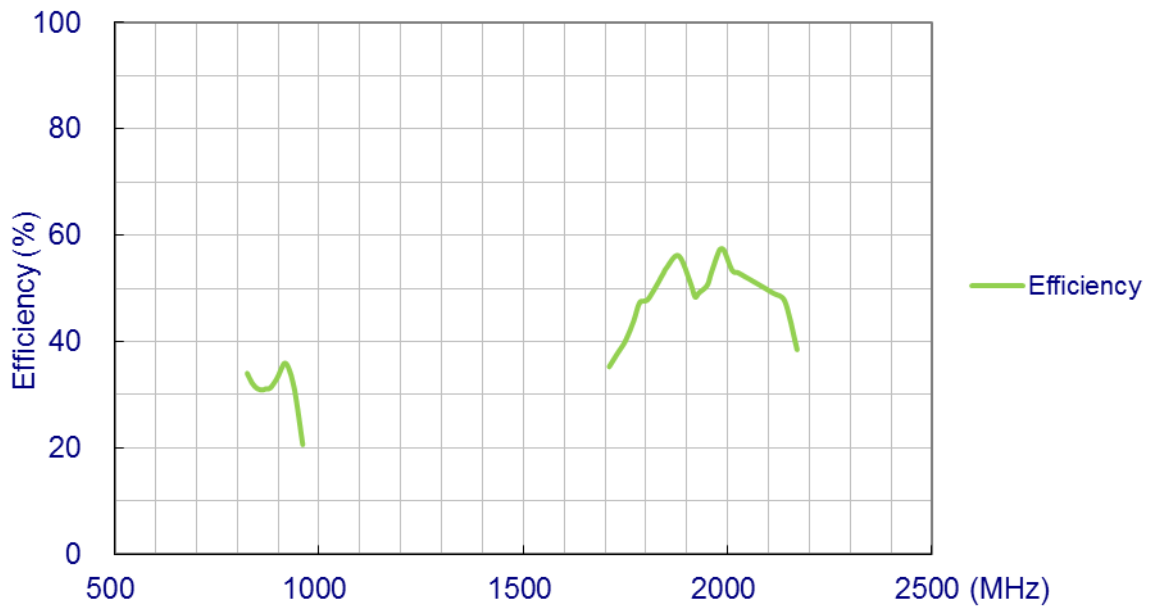

## 4. Radiation Patterns

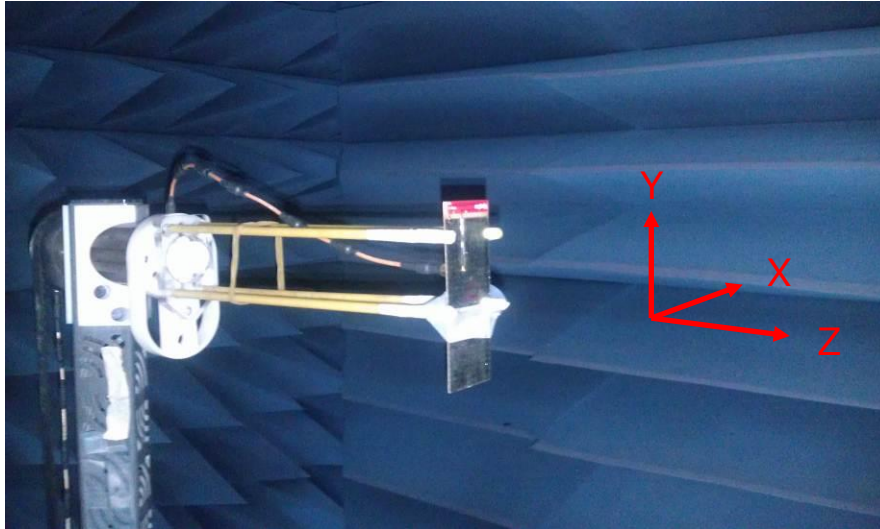

XY Plane

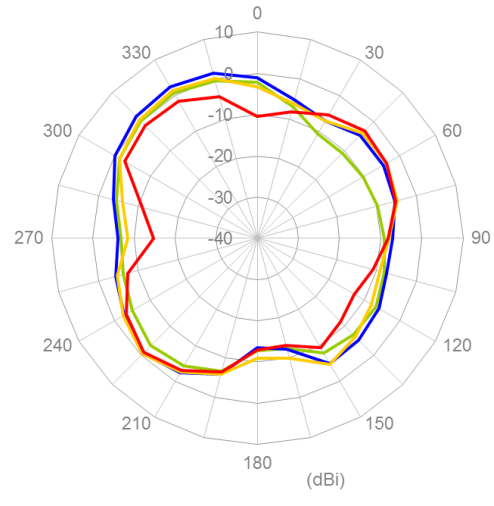
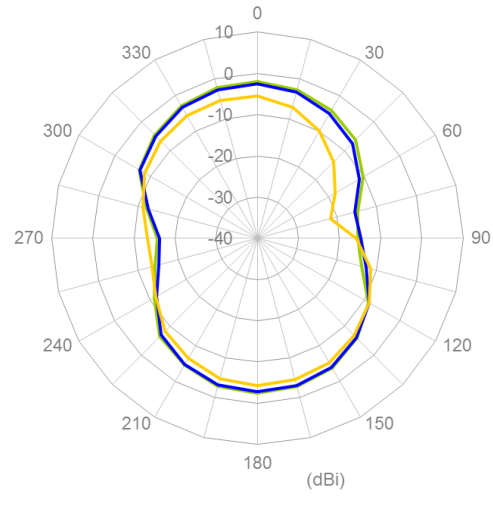

XZ plane

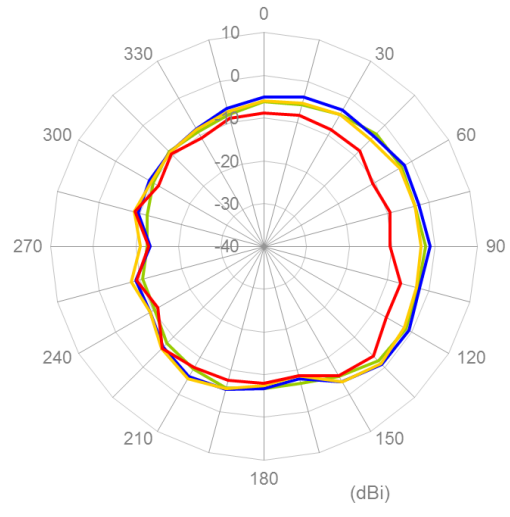
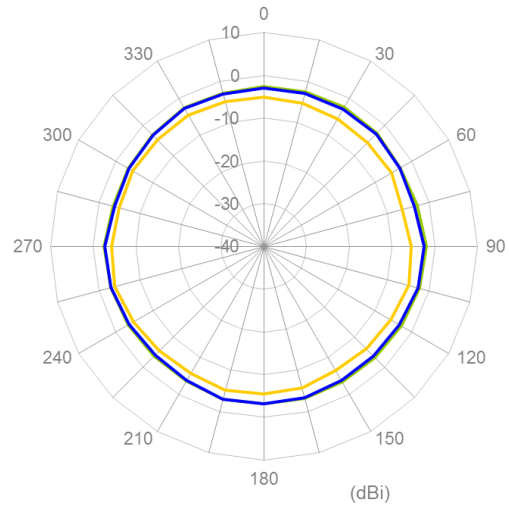

## 5. Matching Circuits

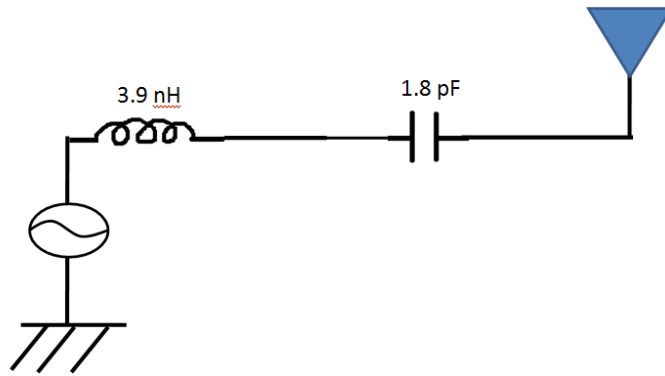



## 6. Drawing

### 6.1. PCS.07.A Antenna

Top View

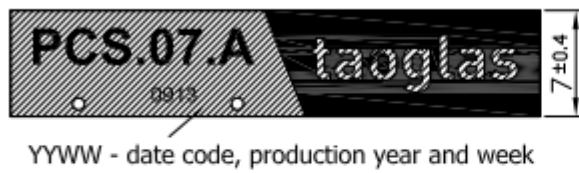

Bottom View

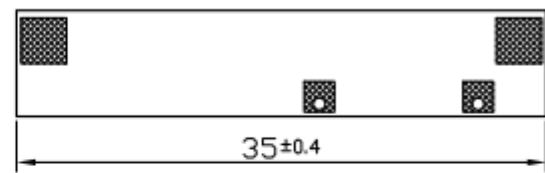

Side View

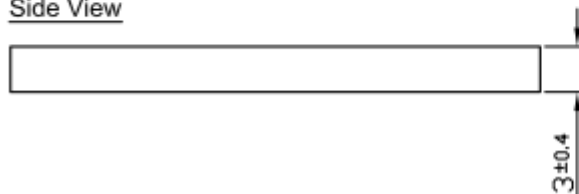

### 6.2. PCS.07.A Footprint



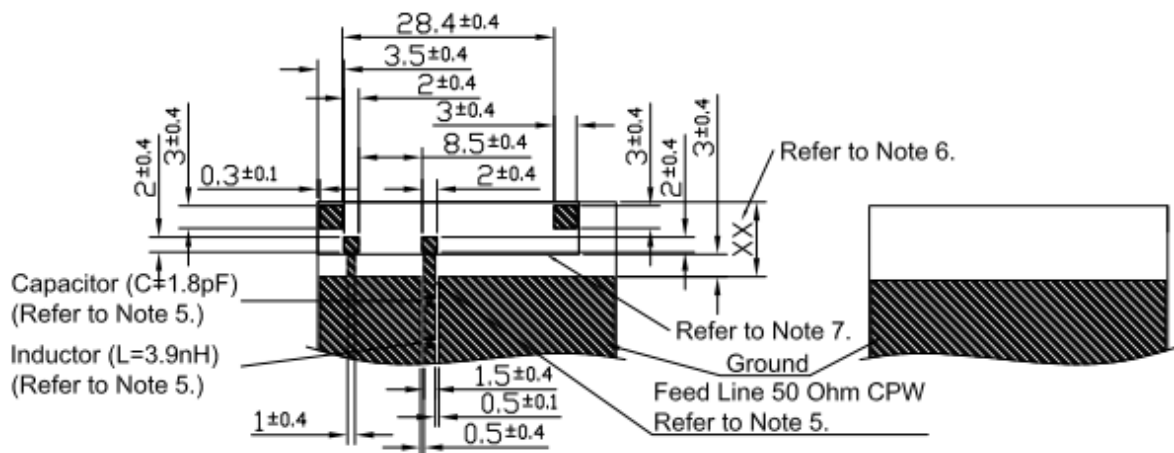

Footprint  
0.8t PCB

Top View

Bottom View



#### Notes

- |                       |   |   |
|-----------------------|---|---|
| 1. Tin Plated         |  | 5. Matching circuit - value changes according to ground and layout. |
| 2. Silkscreen (Black) |  | 6. Antenna outline for placement reference.                         |
| 3. Soldermask (Gold)  |  | 7. Keep out area.   |
| 4. Copper             |  |   |

### 6.3. PCS.07.A Evaluation Board

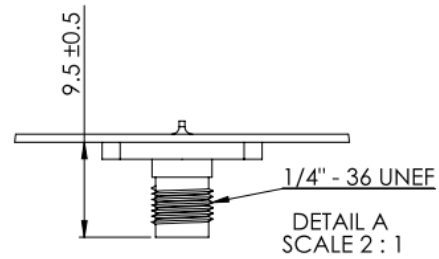
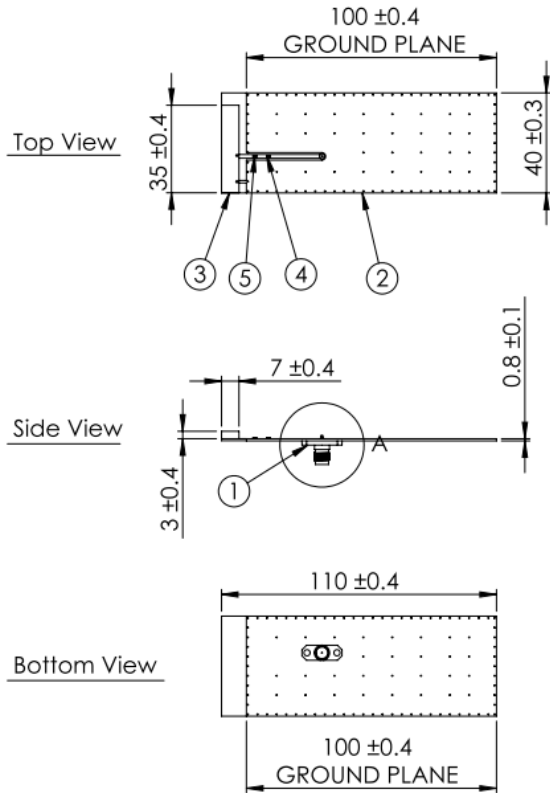

#	Name	Material	Finish	Qty
1	PCB SMA(F) ST	Brass	Gold	1
2	PCSD.07.A PCB	FR4 0.8t	Gold	1
3	PCS.07.A	FR4 3.0t	Gold	1
4	Inductor (L=3.9nH)	Ceramic	N/A	1
5	Capacitor (C=1.8pF)	Ceramic	N/A	1



1000 pcs PCS.07.A reel  
 Dimensions - 330\*330\*60mm  
 Weight -2110g

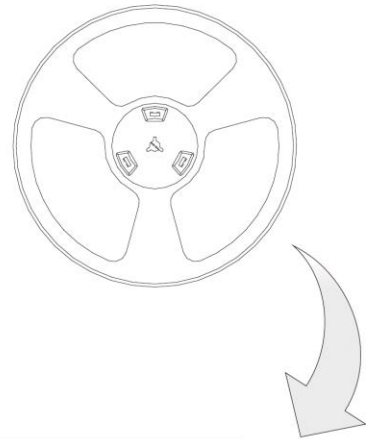

1000 pcs PCS.07.A / 1 Reel in small box  
 Dimensions - 337\*337\*87mm  
 Weight -2.39Kg

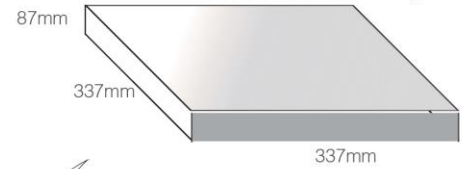

4 reels, 4000 pcs in one carton  
 Carton Dimensions - 370\*360\*370mm  
 Weight -10.44Kg

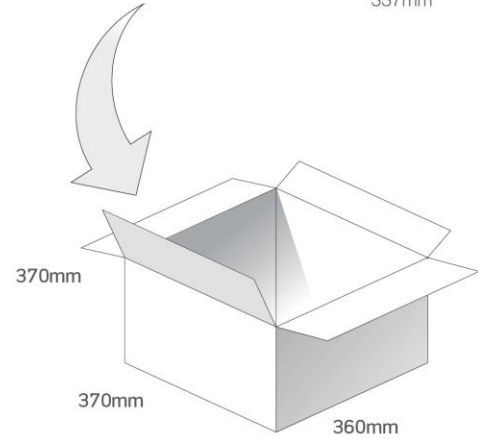

Pallet Dimensions 1200\*1000\*1310mm  
 18 Cartons per Pallet  
 6 Cartons per layer  
 4 Layers

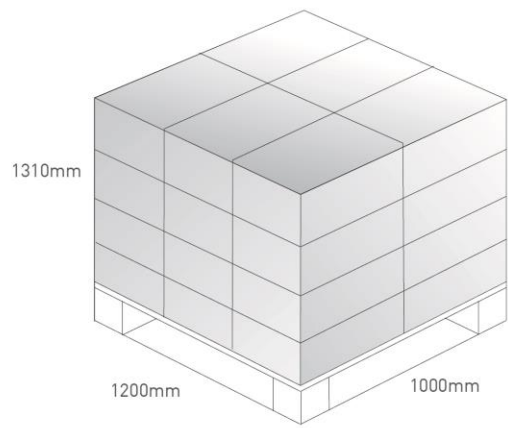

## 8. Application Note

Investigations of PCS.07.A antenna performance on different lengths of ground plane were conducted, the return loss is shown as below.

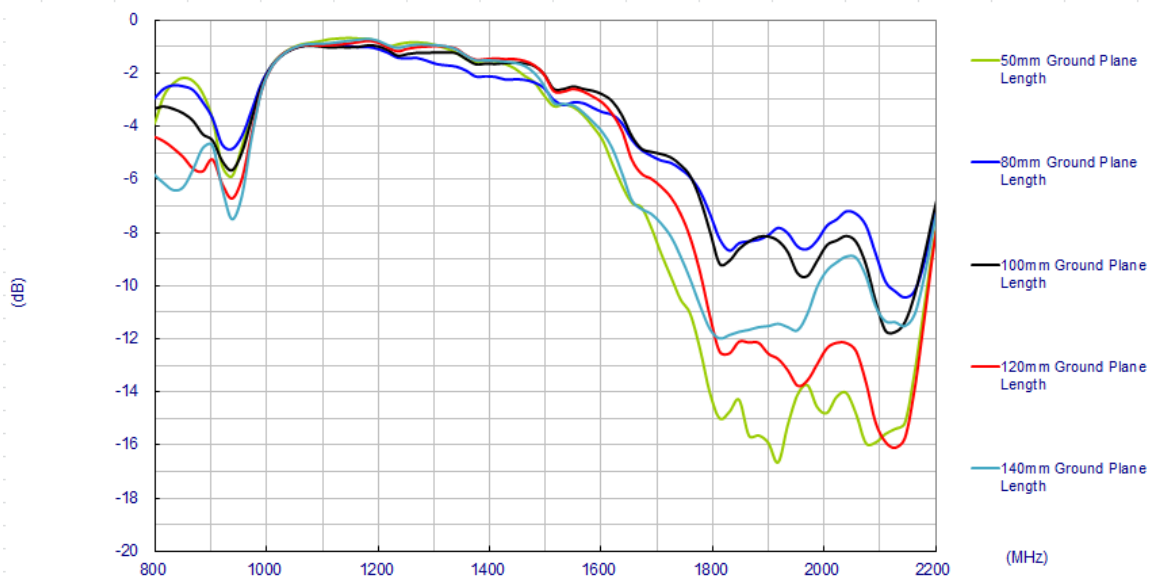

The antenna performance are shown on below,

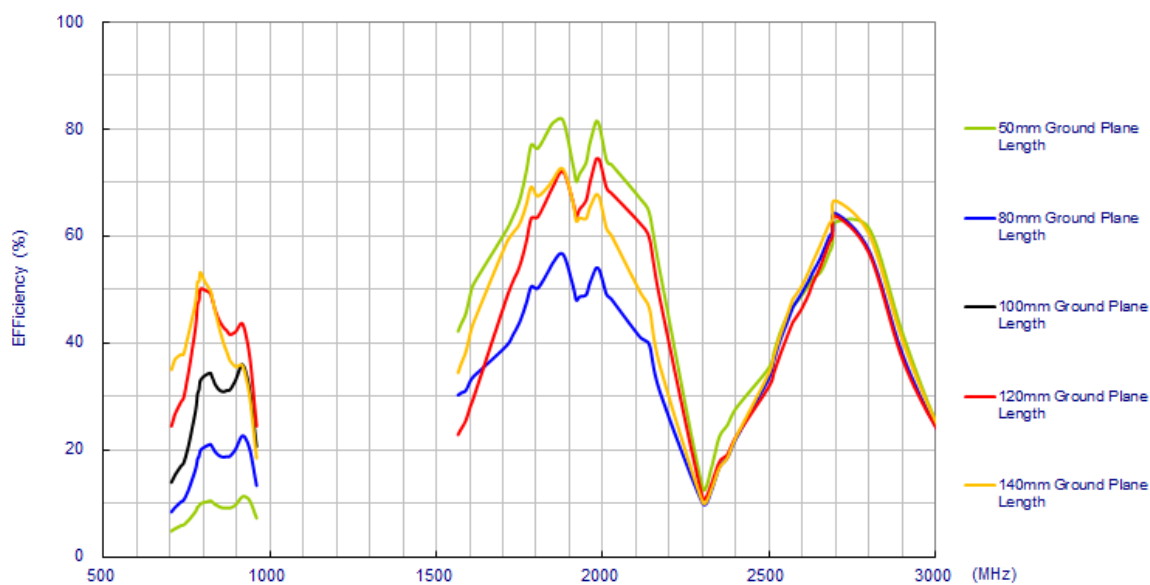

Efficiency

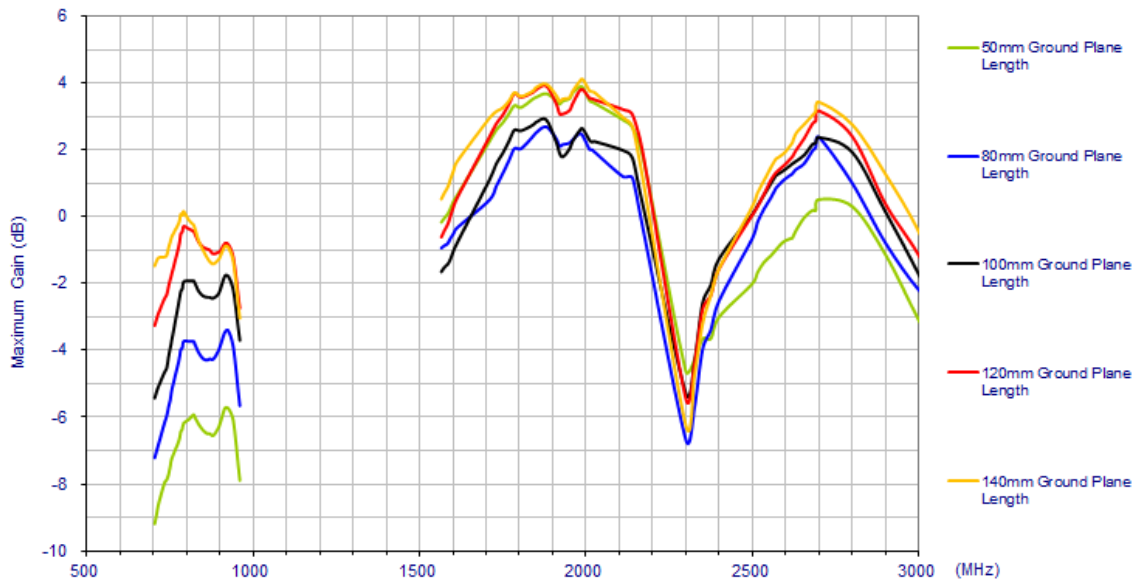

Maximum Gain

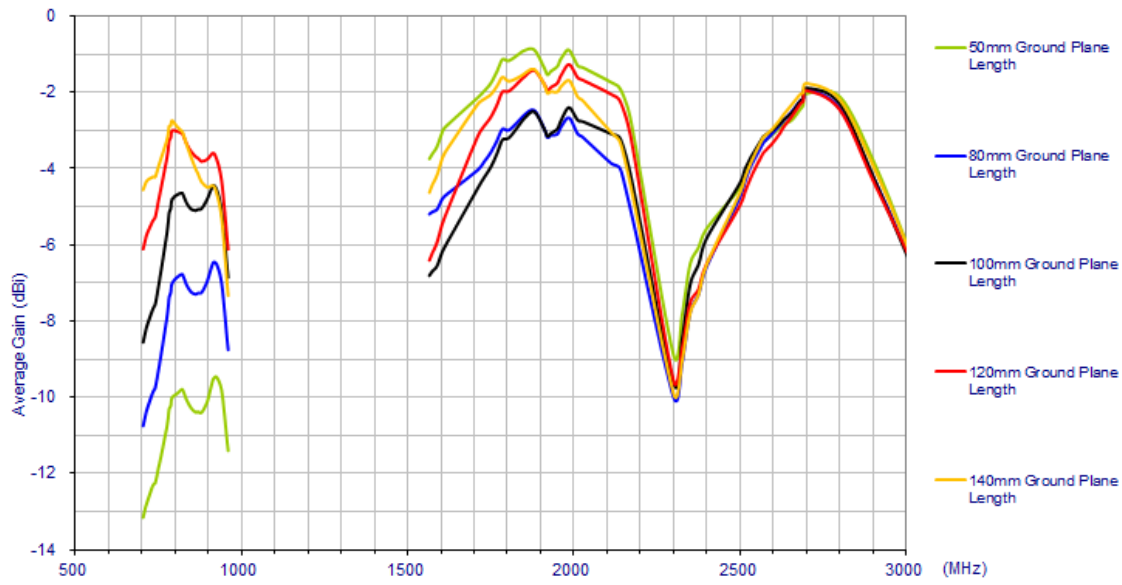

Average Gain

Taoglas makes no warranties based on the accuracy or completeness of the contents of this document and reserves the right to make changes to specifications and product descriptions at any time without notice. Taoglas reserves all rights to this document and the information contained herein.

Reproduction, use or disclosure to third parties without express permission is strictly prohibited.

Copyright © Taoglas Ltd.