

NOTES:

1. MATERIAL HOUSING: GLASS FILLED LCP (LIQUID CRYSTAL POLYMER), UL94V-0, COLOR-BLACK, CONTACT: COPPER ALLOY.
2. FINISH: SELECT GOLD - 0.76 MICROMETER/30 MICROINCH MINIMUM, SELECT TIN - 3.81 MICROMETER/150 MICROINCH MINIMUM, BOTH OVER NICKEL - 1.27 MICROMETER/50 MICROINCH MINIMUM.
3. POWER TERMINALS LUBRICATED IN CONTACT AREA.
4. PRODUCT SPECIFICATION: PS-45984-001.
5. PACKAGING: TRAY PER PK-45984-001.
6. SEE SHEET 5 FOR CKT IDENTIFICATION.
7. PARTS ARE RoHS COMPLIANT.
8. PEG HOLES ARE OPTIONAL SEE SHEET 3 AND 4.
9. MATES TO 1577.062 CARD EDGE OR MOLEX P/N 45985-8\*\*\*.

NO OF SIGNAL	MATERIAL NUMBER	DIM A	DIM P	PCB THK
12	45984-8111	59.5	4.50	3.18
16	45984-8121	62.0		
20	45984-8131	64.6		
24	45984-8141	67.1		
28	45984-8151	69.6	3.60	2.36
32	45984-8161	72.2		
36	45984-8171	74.7		
40	45984-8181	77.3		
12	45984-8112	59.5	2.90	1.57
16	45984-8122	62.0		
20	45984-8132	64.6		
24	45984-8142	67.1		
28	45984-8152	69.6	-	-
32	45984-8162	72.2		
36	45984-8172	74.7		
40	45984-8182	77.3		
12	45984-8113	59.5	-	-
16	45984-8123	62.0		
20	45984-8133	64.6		
24	45984-8143	67.1		
28	45984-8153	69.6	-	-
32	45984-8163	72.2		
36	45984-8173	74.7		
40	45984-8183	77.3		

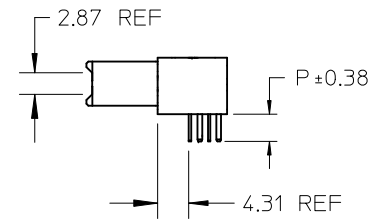
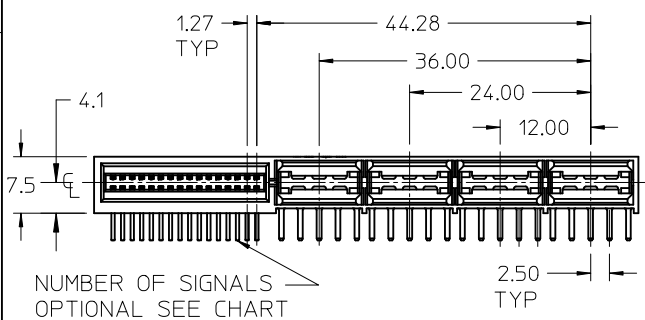
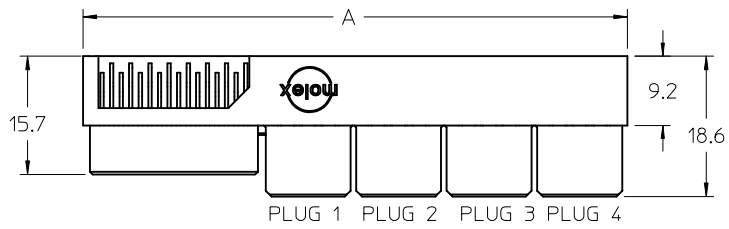

NUMBER OF SIGNALS  
OPTIONAL SEE CHART

Ø 1.02 ± 0.05 TYP  
⊕ Ø 0.05 (M) A B C

Ø 0.76 ± 0.05 TYP  
⊕ Ø 0.05 (M) A B C

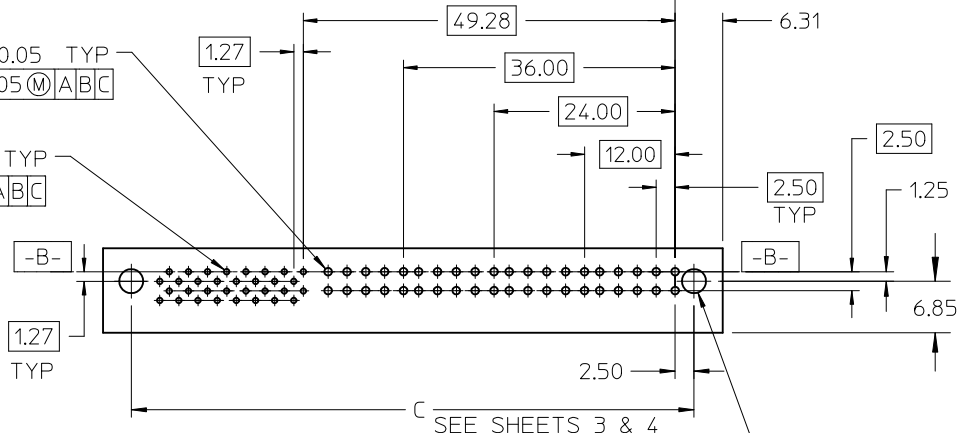

PCB LAYOUT: COMPONENT SIDE  
PEG HOLES OPTIONAL

Ø 3.18 ± 0.08 TYP  
PEG HOLES 7

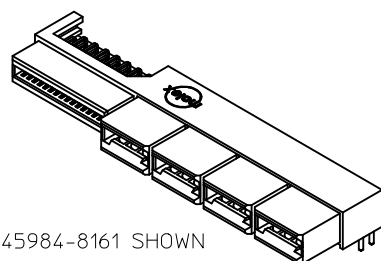

45984-8161 SHOWN  
FOR REF ONLY  
SEE CHART

REV	DESCRIPTION
5	MODIFY HSG NOTE EC NO: UCP2012-0902 DRWN:DMORGAN 2011/09/28 CHKD:MBARRA 2011/09/28 APPR:SMILLER 2011/11/09

QUALITY SYMBOLS		GENERAL TOLERANCES (UNLESS SPECIFIED)	
mm	INCH	mm	INCH
4 PLACES	± ---	± ---	± ---
3 PLACES	± ---	± ---	± ---
2 PLACES	± 0.25	± ---	± ---
1 PLACE	± ---	± ---	± ---
ANGULAR ± 1/2°			
DRAFT WHERE APPLICABLE MUST REMAIN WITHIN DIMENSIONS			

DIMENSION STYLE		SCALE	DESIGN UNITS	THIRD ANGLE PROJECTION
MM ONLY		1:1	METRIC	⊕
DRAWN BY	DATE	TITLE		
SAMIEC	2005/05/13	LPH RECEPTACLE ASSEMBLY RT ANGLE 8 CIRCUIT POWER CONNECTOR		
CHECKED BY	DATE	MOLEX INCORPORATED		
SAMIEC	2005/05/13	DOCUMENT NO. SD-45984-800		
APPROVED BY	DATE	SHEET NO. 1 OF 5		
MARGULIS	2005/05/13	THIS DRAWING CONTAINS INFORMATION THAT IS PROPRIETARY TO MOLEX INCORPORATED AND SHOULD NOT BE USED WITHOUT WRITTEN PERMISSION		
MATERIAL NO.	SEE CHART			
SIZE	A			

6

5

4

3

2

1

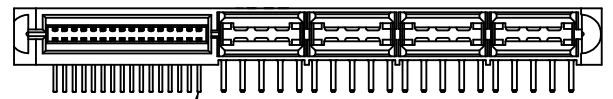
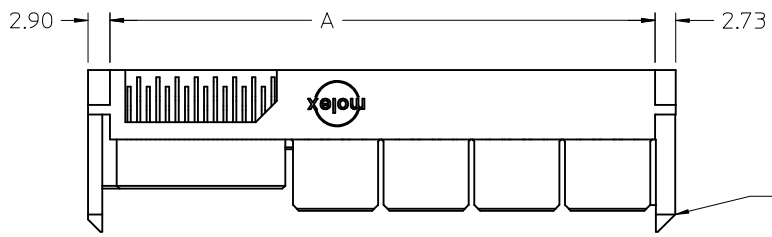

NO OF SIGNALS  
OPTIONAL  
SEE CHART

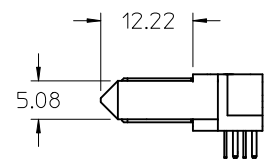

GUIDE POST OPTIONS

NO OF SIGNAL	MATERIAL NUMBER	DIM A	DIM P	PCB THK
12	45984-8211	59.5	4.50	3.18
16	45984-8221	62.0		
20	45984-8231	64.6		
24	45984-8241	67.1		
28	45984-8251	69.6		
32	45984-8261	72.2	3.60	2.36
36	45984-8271	74.7		
40	45984-8281	77.3		
12	45984-8212	59.5		
16	45984-8222	62.0		
20	45984-8232	64.6	2.90	1.57
24	45984-8242	67.1		
28	45984-8252	69.6		
32	45984-8262	72.2		
36	45984-8272	74.7		
40	45984-8282	77.3	2.90	1.57
12	45984-8213	59.5		
16	45984-8223	62.0		
20	45984-8233	64.6		
24	45984-8243	67.1	2.90	1.57
28	45984-8253	69.6		
32	45984-8263	72.2		
36	45984-8273	74.7		
40	45984-8283	77.3		

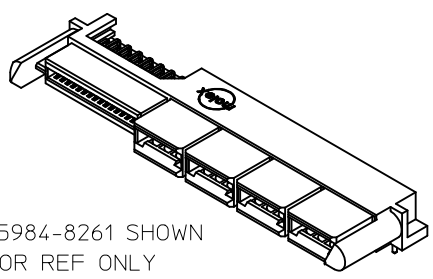

45984-8261 SHOWN  
FOR REF ONLY  
SEE CHART

SEE SHEET 1 EC NO: UCP2012-0902 DRWN:DMORGAN 2011/09/28 CH'KD:MIBARRA 2011/09/28 APPR:SMILLER 2011/11/09	QUALITY SYMBOLS 	GENERAL TOLERANCES (UNLESS SPECIFIED)		DIMENSION STYLE <b>MM ONLY</b>		SCALE <b>1:1</b>	DESIGN UNITS <b>METRIC</b>	THIRD ANGLE PROJECTION		
			mm	INCH	DRAWN BY	DATE	TITLE <b>LPH RECEPTACLE ASSEMBLY          RT ANGLE 8 CIRCUIT          POWER CONNECTOR</b>			
			4 PLACES ± ---	± ---	SAMIEC	2005/05/13				
			3 PLACES ± ---	± ---	CHECKED BY	DATE	<b>MOLEX INCORPORATED</b>			
		2 PLACES ± 0.25	± ---	SAMIEC	2005/05/13					
		1 PLACE ± ---	± ---	APPROVED BY	DATE	DOCUMENT NO. <b>SD-45984-800</b>		SHEET NO. <b>2 OF 5</b>		
		ANGULAR ± 1/2°		MATERIAL NO. <b>SEE CHART</b>		THIS DRAWING CONTAINS INFORMATION THAT IS PROPRIETARY TO MOLEX INCORPORATED AND SHOULD NOT BE USED WITHOUT WRITTEN PERMISSION				
		DRAFT WHERE APPLICABLE MUST REMAIN WITHIN DIMENSIONS								

5

4

3

2

1

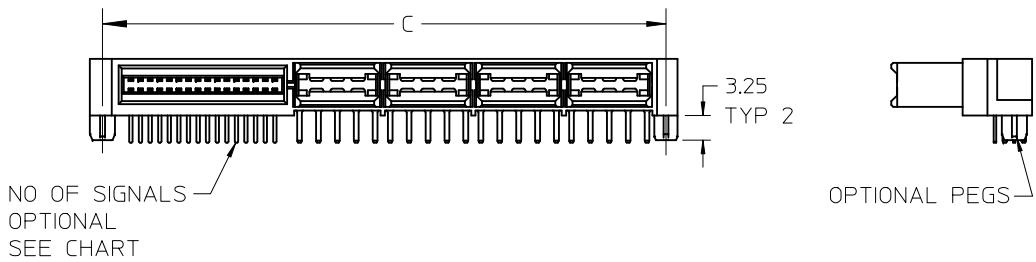
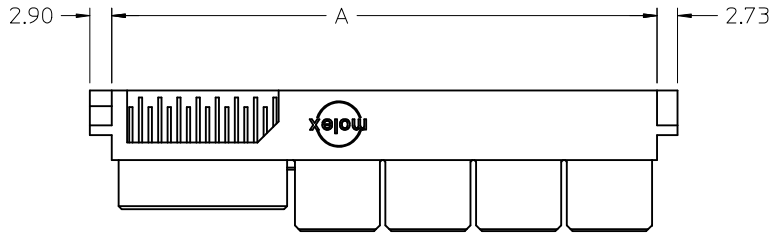

NO OF SIGNALS  
OPTIONAL  
SEE CHART

MOUNTING PEG OPTIONS

NO OF SIGNAL	MATERIAL NUMBER	DIM A	DIM C	DIM P	PCB THK
12	45984-8311	59.5	61.90	4.50	3.18
16	45984-8321	62.0	64.44		
20	45984-8331	64.6	66.98		
24	45984-8341	67.1	69.52		
28	45984-8351	69.6	72.06		
32	45984-8361	72.2	74.60		
36	45984-8371	74.7	77.14	3.60	2.36
40	45984-8381	77.3	79.68		
12	45984-8312	59.5	61.90		
16	45984-8322	62.0	64.44		
20	45984-8332	64.6	66.98		
24	45984-8342	67.1	69.52		
28	45984-8352	69.6	72.06	2.90	1.57
32	45984-8362	72.2	74.60		
36	45984-8372	74.7	77.14		
40	45984-8382	77.3	79.68		
12	45984-8313	59.5	61.90		
16	45984-8323	62.0	64.44		
20	45984-8333	64.6	66.98	2.90	1.57
24	45984-8343	67.1	69.52		
28	45984-8353	69.6	72.06		
32	45984-8363	72.2	74.60		
36	45984-8373	74.7	77.14		
40	45984-8383	77.3	79.68		

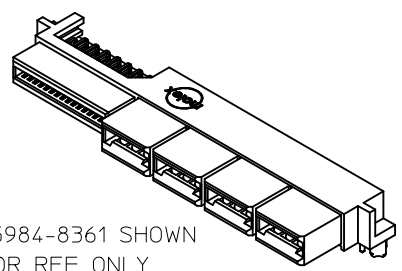

45984-8361 SHOWN  
FOR REF ONLY  
SEE CHART

SEE SHEET 1 EC NO: UCP2012-0902 DRWN:DMORGAN 2011/09/28 CH'KD:MIBARRA 2011/09/28 APPR:SMILLER 2011/11/09	QUALITY SYMBOLS $\nabla \text{F} = 0$ $\nabla \text{E} = 0$ $\nabla \text{P} = 0$	GENERAL TOLERANCES (UNLESS SPECIFIED) <table border="1"> <thead> <tr> <th></th> <th>mm</th> <th>INCH</th> </tr> </thead> <tbody> <tr><td>4 PLACES</td><td><math>\pm</math> ---</td><td><math>\pm</math> ---</td></tr> <tr><td>3 PLACES</td><td><math>\pm</math> ---</td><td><math>\pm</math> ---</td></tr> <tr><td>2 PLACES</td><td><math>\pm 0.25</math></td><td><math>\pm</math> ---</td></tr> <tr><td>1 PLACE</td><td><math>\pm</math> ---</td><td><math>\pm</math> ---</td></tr> </tbody> </table>		mm	INCH	4 PLACES	$\pm$ ---	$\pm$ ---	3 PLACES	$\pm$ ---	$\pm$ ---	2 PLACES	$\pm 0.25$	$\pm$ ---	1 PLACE	$\pm$ ---	$\pm$ ---	DIMENSION STYLE <b>MM ONLY</b> DRAWN BY: SAMIEC DATE: 2005/05/13 CHECKED BY: SAMIEC DATE: 2005/05/13 APPROVED BY: MARGULIS DATE: 2005/05/13	SCALE: 1:1 DESIGN UNITS: METRIC THIRD ANGLE PROJECTION	TITLE: LPH RECEPTACLE ASSEMBLY RT ANGLE 8 CIRCUIT POWER CONNECTOR MOLEX INCORPORATED DOCUMENT NO. SD-45984-800 SHEET NO. 3 OF 5
		mm	INCH																	
	4 PLACES	$\pm$ ---	$\pm$ ---																	
	3 PLACES	$\pm$ ---	$\pm$ ---																	
2 PLACES	$\pm 0.25$	$\pm$ ---																		
1 PLACE	$\pm$ ---	$\pm$ ---																		
DRAFT WHERE APPLICABLE MUST REMAIN WITHIN DIMENSIONS	SIZE: A THIS DRAWING CONTAINS INFORMATION THAT IS PROPRIETARY TO MOLEX INCORPORATED AND SHOULD NOT BE USED WITHOUT WRITTEN PERMISSION																			

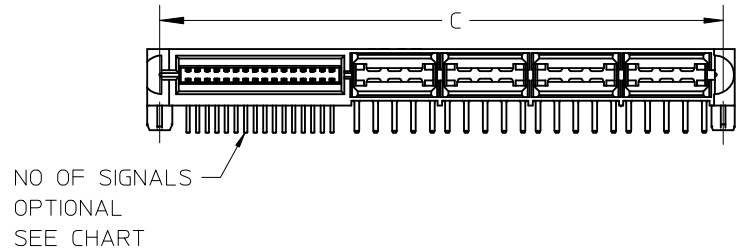
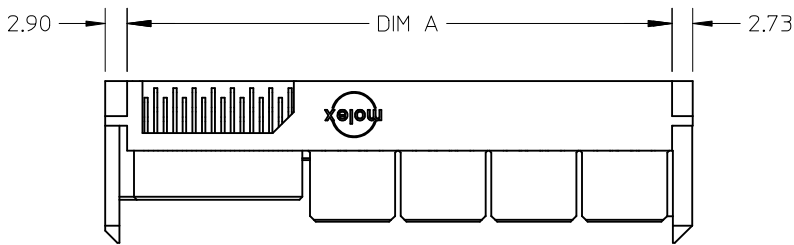

OPTIONAL GUIDES

OPTIONAL PEGS

NO OF SIGNALS  
OPTIONAL  
SEE CHART

### GUIDE POST & MOUNTING PEG OPTIONS

NO OF SIGNAL	MATERIAL NUMBER	DIM A	DIM C	DIM P	PCB THK
12	45984-8411	59.5	61.90	4.50	3.18
16	45984-8421	62.0	64.44		
20	45984-8431	64.6	66.98		
24	45984-8441	67.1	69.52		
28	45984-8451	69.6	72.06		
32	45984-8461	72.2	74.60		
36	45984-8471	74.7	77.14	3.60	2.36
40	45984-8481	77.3	79.68		
12	45984-8412	59.5	61.90		
16	45984-8422	62.0	64.44		
20	45984-8432	64.6	66.98		
24	45984-8442	67.1	69.52		
28	45984-8452	69.6	72.06		
32	45984-8462	72.2	74.60		
36	45984-8472	74.7	77.14	2.90	1.57
40	45984-8482	77.3	79.68		
12	45984-8413	59.5	61.90		
16	45984-8423	62.0	64.44		
20	45984-8433	64.6	66.98		
24	45984-8443	67.1	69.52		
28	45984-8453	69.6	72.06		
32	45984-8463	72.2	74.60		
36	45984-8473	74.7	77.14		
40	45984-8483	77.3	79.68		

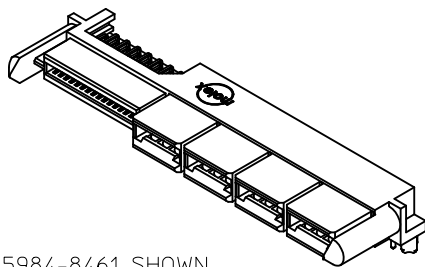

45984-8461 SHOWN  
FOR REF ONLY  
SEE CHART

SEE SHEET 1 EC NO: UCP2012-0902 DRWN:DMORGAN 2011/09/28 CHKD:MI BARRA 2011/09/28 APPR:SMILLER 2011/11/09	QUALITY SYMBOLS 	GENERAL TOLERANCES (UNLESS SPECIFIED)		DIMENSION STYLE <b>MM ONLY</b>		SCALE <b>1:1</b>	DESIGN UNITS <b>METRIC</b>	THIRD ANGLE PROJECTION		
			mm	INCH	DRAWN BY SAMIEC	DATE 2005/05/13	TITLE <b>LPH RECEPTACLE ASSEMBLY RT ANGLE 8 CIRCUIT POWER CONNECTOR</b>			
		4 PLACES	± ---	± ---	CHECKED BY SAMIEC	DATE 2005/05/13				
		3 PLACES	± ---	± ---	APPROVED BY MARGULIS		DATE 2005/05/13		<b>MOLEX INCORPORATED</b>	
2 PLACES	± 0.25	± ---	MATERIAL NO. <b>SEE CHART</b>		DOCUMENT NO. <b>SD-45984-800</b>		SHEET NO. <b>4 OF 5</b>			
1 PLACE	± ---	± ---	DRAFT WHERE APPLICABLE MUST REMAIN WITHIN DIMENSIONS							
		ANGULAR ±1/2°		SIZE <b>A</b>		THIS DRAWING CONTAINS INFORMATION THAT IS PROPRIETARY TO MOLEX INCORPORATED AND SHOULD NOT BE USED WITHOUT WRITTEN PERMISSION				

SIGNAL CKT 17  
TOP ROW  
BOTTOM ROW  
SIGNAL CKT 1

PLUG 1 PLUG 2 PLUG 3 PLUG 4

TOP ROW  
BOTTOM ROW

NO. OF SIGNAL	DIM. D
12	8.00
16	10.54
20	13.08
24	15.62
28	18.16
32	20.70
36	23.24
40	25.78

SIGNAL 32 CKT

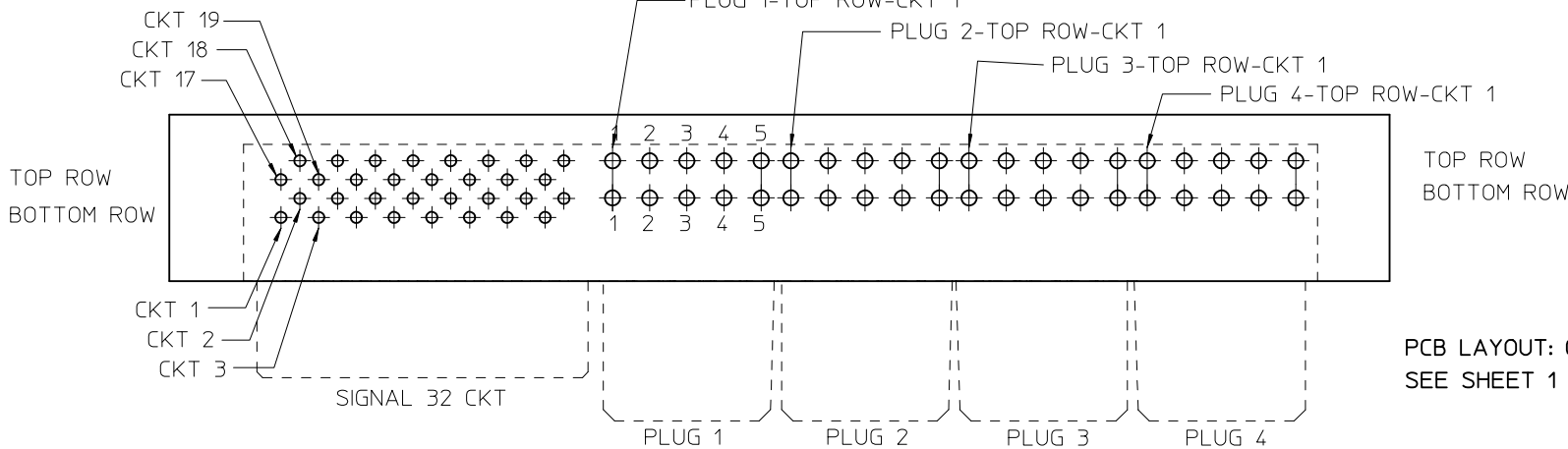
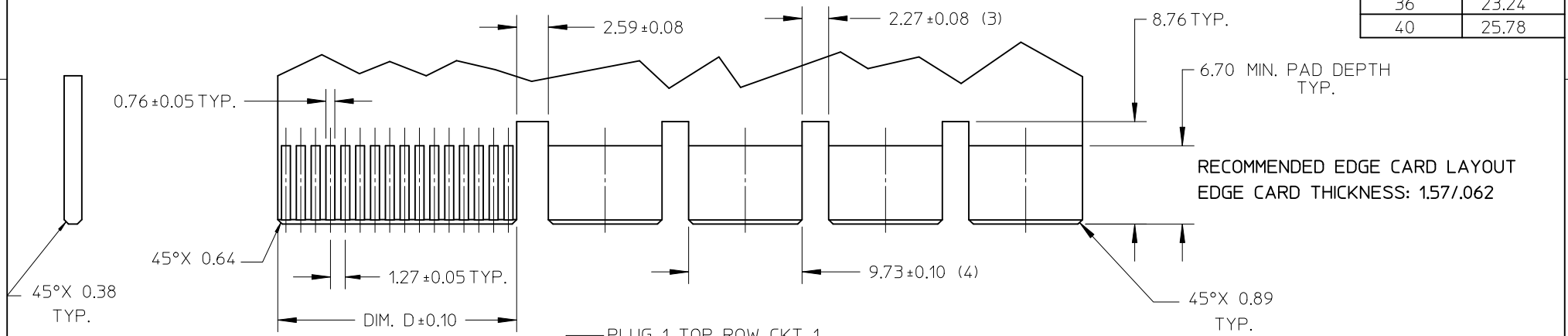

PCB LAYOUT: COMPONENT SIDE  
SEE SHEET 1 FOR DIMENSIONS

SEE SHEET 1 EC NO: UCP2012-0902 DRWN: DMORGAN 2011/09/28 CHKD: MIBARRA 2011/09/28 APPR: SMILLER 2011/11/09	QUALITY SYMBOLS 	GENERAL TOLERANCES (UNLESS SPECIFIED)		DIMENSION STYLE <b>MM ONLY</b>		SCALE <b>2:1</b>	DESIGN UNITS <b>METRIC</b>	THIRD ANGLE PROJECTION	
		mm	INCH	DRAWN BY SAMIEC	DATE 2005/05/13	TITLE <b>LPH RECEPTACLE ASSEMBLY          RT ANGLE 8 CIRCUIT          POWER CONNECTOR</b>			
		4 PLACES ± ---	± ---	CHECKED BY SAMIEC	DATE 2005/05/13				
		3 PLACES ± ---	± ---	APPROVED BY MARGULIS	DATE 2005/05/13	<b>MOLEX INCORPORATED</b>			
2 PLACES ± 0.25	± ---	MATERIAL NO. <b>SEE CHARTS</b>		DOCUMENT NO. <b>SD-45984-800</b>	SHEET NO. <b>5 OF 5</b>				
1 PLACE ± ---	± ---	DRAFT WHERE APPLICABLE MUST REMAIN WITHIN DIMENSIONS		THIS DRAWING CONTAINS INFORMATION THAT IS PROPRIETARY TO MOLEX INCORPORATED AND SHOULD NOT BE USED WITHOUT WRITTEN PERMISSION					
ANGULAR ± 1/2°									