

BLACK 0987731011  
 COLOR MOLEX P/N

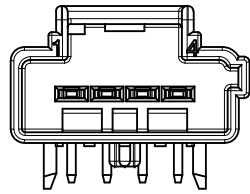

GREY 0987731018  
 COLOR MOLEX P/N

CODINGS

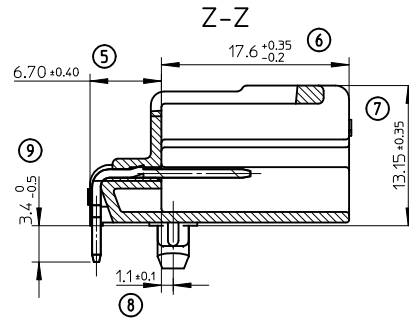
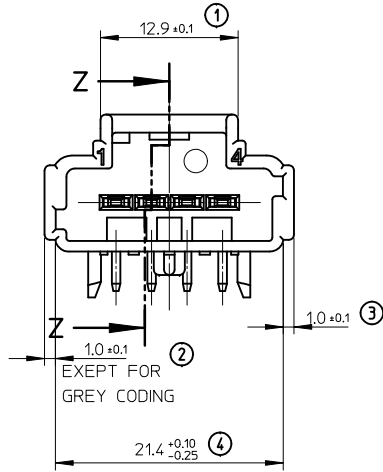
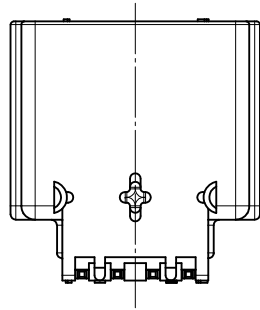

HEADER SUPPORT HOLE DIMENSION

THICKNESS OF PRINTED CIRCUIT 1.6 ± 0.16

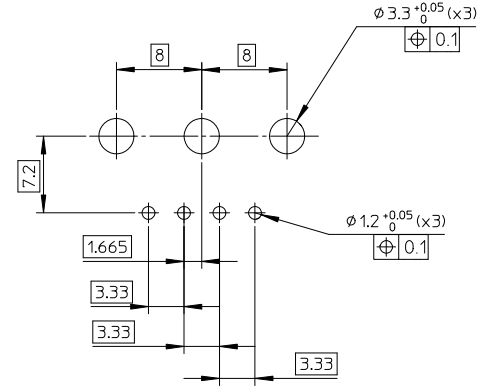

DATE, MONTH AND YEAR

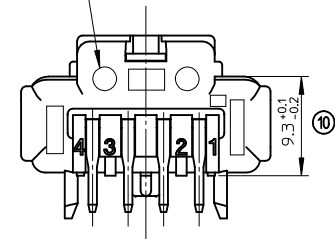

NOTE:

PACKAGING : PK-98773-001  
 APPLICATION SPEC : AS-98773-001

ITEM	QTY	DESCRIPTION	MATERIAL	WEIGHT
2	4	PIN 1.5 X 0.8	BRASS-TIN PLATED	2.73 g
1	1	HEADER 1.5X0.8 4CKT	>PA66<	

INSPECTION BALLOON NUMBER LOG

PER DRAWING REVISION: A  
 LAST BALLOON NUMBER USED: 10  
 ADDED BALLOON NUMBERS:  
 REMOVED BALLOON NUMBERS:

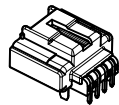
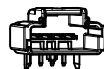

SCALE 1:1

<b>FIRST RELEASE</b> EC NO: G2012-0175 DRAWN: VJOUAS 2012/04/10 CHKD: AHERBEL IN 2012/04/12 APPR: OPLESSIS 2012/04/20	QUALITY SYMBOLS ▽=0 ▽=0 ▽=0	GENERAL TOLERANCES (UNLESS SPECIFIED)		DIMENSION STYLE <b>MM ONLY</b>	SCALE <b>3:1</b>	DESIGN UNITS <b>METRIC</b>	FIRST ANGLE PROJECTION	
		4 PLACES ± --- ± ---	mm INCH	DRAWN BY VJOUAS	DATE 2012/04/10	TITLE <b>HEADER W/ 1.5X0.8 4CKT</b>		
		3 PLACES ± --- ± ---	± 0.20 ± ---	CHECKED BY AHERBEL IN	DATE 2012/04/12	<b>molex</b>		
		2 PLACES ± 0.2 ± ---	± 0.2 ± ---	APPROVED BY OPLESSIS	DATE 2012/04/20	MATERIAL NO. <b>SD-98773-001</b>	DOCUMENT NO.	SHEET NO. <b>1 OF 1</b>
1 PLACE ± 0.2 ± ---	± 0.2 ± ---	ANGULAR ± 3 °		<b>SEE CHART</b>				
0 PLACE ± 0.2 ± ---	± 0.2 ± ---	DRAFT WHERE APPLICABLE MUST REMAIN WITHIN DIMENSIONS		THIS DRAWING CONTAINS INFORMATION THAT IS PROPRIETARY TO MOLEX INCORPORATED AND SHOULD NOT BE USED WITHOUT WRITTEN PERMISSION				